



medemagroup



Serial number: \_\_\_\_ - \_\_\_\_\_ - \_\_\_\_\_ - \_\_\_\_\_

Delivery date: \_\_\_\_\_ Year 20\_\_\_\_\_

**This vehicle was supplied by:** \_\_\_\_\_ **Date:** \_\_\_\_\_ / \_\_\_\_\_

---

## Contents

Symbols.....	4
Warning! .....	4
Introduction.....	5
Declaration of conformity .....	6
Control panel .....	7
User menu .....	8
Programming the User Menu .....	11
Preparations / Adjustments prior to use .....	13
Electric seat adjustment .....	14
Seat rotation.....	15
Steering column .....	16
Serial number.....	17
Driving the Mini Crosser M <sup>2</sup> .....	18
Specific driving situations.....	23
Long hills/difficult ground .....	25
Anti-tilt wheels / stabilisers .....	26
General care and maintenance .....	27
Insurance.....	28
Batteries .....	29
Charging.....	29
Battery disposal.....	31
Storage .....	31
Cleaning .....	31
Changing the wheels.....	32
Fuses .....	34
Brakes.....	35
Disengagement.....	35
Transporting by motor vehicle.....	36
Securing to vehicle floor with belts .....	37
Transporting by plane .....	40
Towing .....	40
Dimensioned drawing, Mini Crosser M <sup>2</sup> 3W.....	41
Dimensioned drawing, Mini Crosser M <sup>2</sup> 4W.....	42
Introduction to seats - Ergo Standard .....	43
Introduction to seats - Mando .....	45
Troubleshooting .....	46
Programming .....	49
Technical data.....	50
Own notes .....	53
International addresses .....	54

## Symbols



Used in the manual to indicate sections describing situations where extra care is required owing to the risk of personal injury.



Used to indicate sections on electromagnetic compatibility (EMC).

---

## Warning!



For safety reasons the vehicle must not be lent to persons who are not completely familiar with it. The vehicle is designed for one person only.



The Mini Crosser M<sup>2</sup> has been designed for users weighing max. 175 kg. Can be supplied in a HD version as standard for a max person weight of 250 kg.

## Introduction

Congratulations on your new Mini Crosser M<sup>2</sup> electric mobility scooter.

You have now taken possession of an electric mobility scooter developed for outdoor driving by active users. It is what is called a Class C vehicle in accordance with the European classification of electric scooters.

For optimum enjoyment of this vehicle - and to avoid breakdowns and accidents - we recommend that you read this User Manual carefully. As a new user, you should pay particular attention to the section entitled "Driving the Mini Crosser M<sup>2</sup>".

The Mini Crosser M<sup>2</sup> is designed for safe travel for at least 10 years, up to a max. of 5,000 hours, provided it is serviced and safety-checked every year, corresponding to 500 hours of operation. The service must be carried out by an authorised workshop.



**IMPORTANT!** For safety reasons it is of the utmost importance that service and safety check intervals are complied with, as this minimises the risk of brake failure and short-circuits in the wiring, which could generate heat and cause a fire.

We offer a wide range of accessories for the Mini Crosser M<sup>2</sup> that can make everyday life easier for you. You are always welcome to contact us for further information on special accessories and adaptations.

Mini Crosser A/S is not responsible for any damage or injuries caused by inappropriate or unsafe use of the Mini Crosser M<sup>2</sup>.

If you have any further questions about the Mini Crosser M<sup>2</sup> or this User Manual, you are always welcome to get in touch. Our contact details are as follows:

**Medema Production A/S**

Tel: +45 7010 2054

Email: [info@minicrosser.com](mailto:info@minicrosser.com)

Internet: [www.medema.com](http://www.medema.com)

NB: Errors and omissions excepted. We reserve the right to update this manual as required.







## Control panel

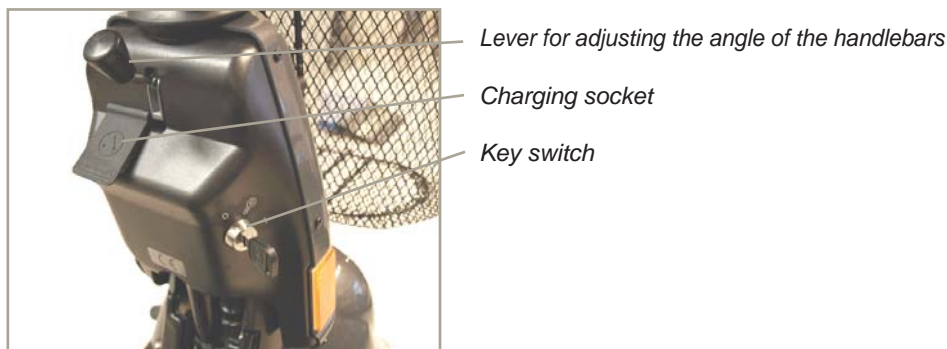
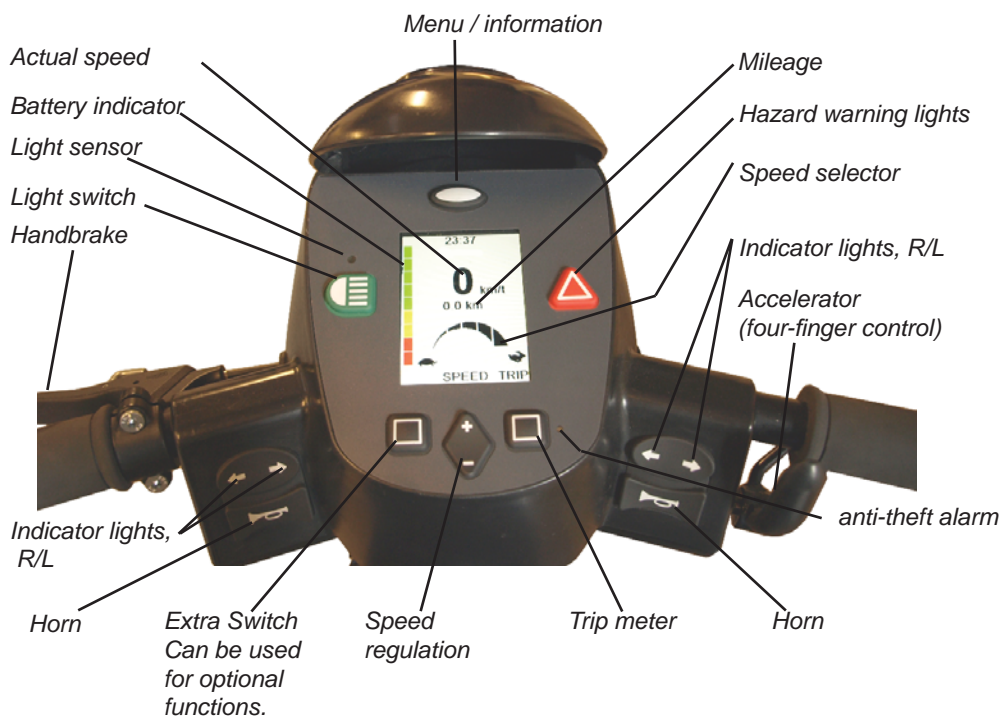



Avoid subjecting the control panel to jarring and knocks. Take care when driving and avoid hitting obstacles.



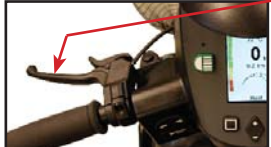

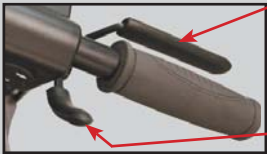
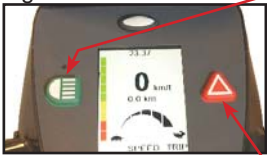
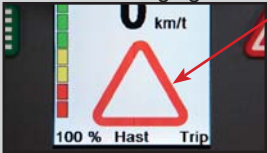

The manufacturer accepts no liability in respect of the unauthorised opening, adjustment or modification of the control panel.

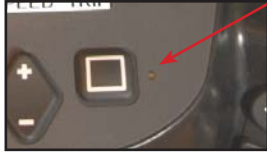

## User menu

Term	Description
<p>Menu / information</p> 	<p>Press the button and a menu at the top of the display switches between "Date", "Time", "Complete km", "Complete running time", "Battery Voltage" Service "and" inclination ". "Slope" is optional, and appears only if it is engaged.</p> <p>Button Menu / information are also used to modify the user parameters.</p> <p>Access these parameters by holding the menu button for approx. 3 sec.</p>
<p>Key switch</p> 	<p>To start the vehicle:</p> <p>Turn the key to position (1). If the Mini Crosser has been used within 24 hours, the display will light up immediately. The Scooter can drive within approx. 1 second. If the Mini Crosser has been turned off for more than 24 hours, it takes more time before the display lights up. The first half second after the Mini Crosser is on, the control is making a safety check of the electrical system. If the accelerator is affected during this time, the Mini Crosser will not be able to run, before the key again has been turned at 0 and back to 1 again.</p>
<p>Speed selector</p> 	<p>The turtle indicates lowest speed range. 0-6 km / h.</p> <p>The hare indicates the highest speed range. Up to 15 km / h. Increase/decrease with + / - button.</p> <p>The icons turtle/hare can be turned on/off from the User menu.</p>
<p>Battery indicator</p> 	<p>The left side of the display shows battery level indicator. Indicates that after approx. 1/2 seconds, the battery state of charge. Provides a more accurate indication after approx. 1 minute drive. When both red, yellow and green box lights are the batteries fully charged. Can be divided into 10 or 3 boxes. When the view is down the bottom of the yellow batteries should be recharged as soon as possible. If there is only light in the red boxes or flashing the batteries must be charged immediately.</p>
<p>Trip meter</p> 	<p>TRIP button resets the trip meter. Can be used while driving.</p>
<p>Hand brake</p> 	<p>Works on the left rear wheel and should only be used as extra brake / emergency brake and parking brake. It can be blocked in the locked position. Also available as a foot brake.</p>

Term	Description
<p>Accelerator</p>  <p>Forw. / Backw.</p>	<p>Front arm activates slowly and the Mini Crosser will start running forward. The more press, the faster it will run. When the lever is released, the arm fl ips itself back to the starting position and Mini Crosser stops. Upon activation of the posterior arm, the Mini Crosser run backward. The Magnetic brake on the rear wheels will strike at standstill, corresponding to the parking brake on a car. With speed regulation, speed can also be regulated downhill. The engine will then act as a brake.</p>
<p>Light switch</p> 	<p>Turns on the front and rear lights. The key switch must however be turned to position 1 (drive).</p>
<p>Hazard warning lights</p> 	<p>Turns on all lamps at once. Also works when the key is removed, or turned to 0 (stop position).</p>
<p>Indicator lights switch</p> 	<p>Arrow left: lamp left side. Arrow Right: lamp right side. Activate the same button again to turn off fl ashing lights.</p>
<p>Horn</p> 	<p>Electric horn which can be programmed in volume in the User Menu. Activated by pressing the horn button.</p>
<p>Charging socket</p> 	<p>Turn off the Mini Crosser (key in position 0) during charging. Note that it is not possible to run while the batteries recharge. See also the section "Batteries and Charging."</p>

Term	Description
<b>Extras</b>	
<p>Anti-theft alarm</p> 	<p>(Extra) With this parameter set to ON, the anti-theft alarm is turned on every time you turn off the Mini Crosser. An activated alarm is turned off by turning the key to 1 (drive). If you have no opportunity to get to the Mini Crosser with the key, the alarm will stop after approx. 20 seconds. Shake the scooter again, the alarm will be activated again.</p>
<p>Tilt</p> 	<p>Tilt-symbols.</p>
<p>Tilt Alarm sideways</p> 	<p>By exceeding the preset value, the symbol flashes and the horn hoots, if the parameter is enabled.</p>
<p>Tilt Alarm forw./backw.</p> 	<p>By exceeding the preset value, the symbol illuminate and the horn hoots, if the parameter is enabled.</p>
<p>Overheating step 1</p> 	<p>Step 1: The symbol flashes and the speed is reduced to half power. Wait for 3-5 min and start again.</p>
<p>Overheating step 2</p> 	<p>Step 2: The symbol will illuminate and Mini Crosser stops. Wait 3-5 minutes and start again.</p>

## Programming the User Menu

Access the menu by holding the Menu/information button for approx. 3 sec. Scroll up and down with the + / -button under the display. The active parameter is highlighted with yellow writing and blue background. Access the value of the selected parameter by pressing Enter. Change the value using the +/- button. Confirm with Enter and exit with the Menu/information button.

Parameter description	
Date Format	Choose between: ddmmyy - day/month/year mmddy - month/day/year yymmdd - year/month/day
Temp. unit (Temp. unit is extra)	Choose between Celsius or Fahrenheit. Displays ambient temperature.
Limited speed (On/Off)	Limited speed On/Off. To edit this function you will be asked for a 4 digit code. From the factory this code is set to be 1234, but it can be altered by a service technician. Use the +/- button to each digit. Go to the next digit with the "Next" button. Confirm with "Enter" Turn this parameter On/Off – Confirm with "Enter".
Limited speed (value)	Limited speed - value. To edit this function you will be asked for a 4 digit code. From the factory this code is set to be 1234, but it can be altered by a service technician. Use the +/- button to set % value, that you want the scooters max speed reduced to. Move in increments of 5%.
Backlight (value)	The displays backlight can be changed in increments of 5%. Typically used in winter or when driving in darkness, where the intense light from the display may seem annoying.
Backlight auto (On/Off)	Selecting "On" reduced intensity of the backlight automatically when darkness falls or when driving into a tunnel or similar. Light sensor sits just above the light switch. See the Control panel.
Backlight threshold	Here max. light intensity is shown in%. Move in increments of 5%.
Reverse Buzzer (Off/ Beep/Buzze)	Same warning horn as it is known from trucks in reverse gear. Choose from "Off", "Beep" - low horns, or "Buzzer" - sharp horns.
Keyboard sound (On/Off)	With ON / OFF select whether to be acknowledged with a little beep when you press the contacts on the dashboard. These are: fl ashing, lights, hazard, menu, arrows and MENU keys.
Blinker sound (Off/ Beep/Buzze)	Choose whether you want a sound when fl ashing lights on the scooter is on. Just as we know it from a car. You can select "Off", "Beep" - low horns, or "Buzzer" - sharp horns.

<b>Parameter description</b>	
Clock	Set time and date using the up / down with arrows. Moving to the next digit by pressing the "next" button. Quit with the "Enter"
Hazard enabled (On/Off)	By default hazard (emergency lights) is operable even if the scooter is switched off and the key is removed. If you wish the hazard not be activated with the scooter turned off, you should select "Off." here.
Alarm enabled (On/Off) Extra	With this switch "On", the burglar alarm is turned on every time you turn off the scooter. The small lamp next to the "Trip meter" will flash a few seconds interval. An activated alarm is turned off by switching the key on the scooter. If you have no opportunity to get to the scooter with the key, the alarm will switch off after approx. 20th seconds. Shake / move the scooter again, the alarm will be activated again.
Tilt Present (On/Off) Extra	With this parameter set to "On", will turn the tilt icons to red and blinking, and there will be a whining tone (if enabled) if you are running on a slope that is steeper than allowed.
P&G fault log	<p>Here are the faults that P &amp; G engine management have registered. The system can record 8 different types of faults. Each fault can be recorded up to 30 times. The newest registered fault is written at the top of the list.</p> <p>They are shown as follows:                      [1502] 2                      None                      None                      None                      None                      None                      None</p> <p>In this case, the fault 1502 appeared twice. If you press ENTER on the fault you will get an explanatory text. In this case, "Solenoid brake fault"</p> <p>None means that there have been other fault.</p> <p>In case of fault on the scooter, it will be a great help if the fault type can be given to the Mini Crosser or his representative during troubleshooting.</p>

Temperature sensor, alarm system and tilt alarm are built into the same box that can be acquired as an option for the Mini Crosser M2.

## Preparations / Adjustments prior to use

### Adjusting the height of the seat

Lift the seat off and remove the rear cover. Press the release button out and adjust the seat tube to the desired position. See the picture on the next page. Check that the seat height is correct and press the release button in again. Move the seat tube up/down until the release clicks into a hole.

Make sure you keep your back straight when lifting the seat, which is very heavy. (See below.)



*Lift the seat off the seat tube.*

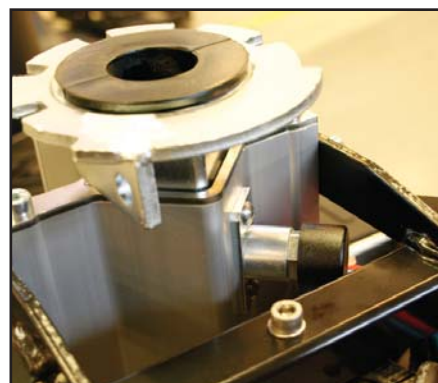

*The release button pressed in. Press the button out to release the seat tube.*

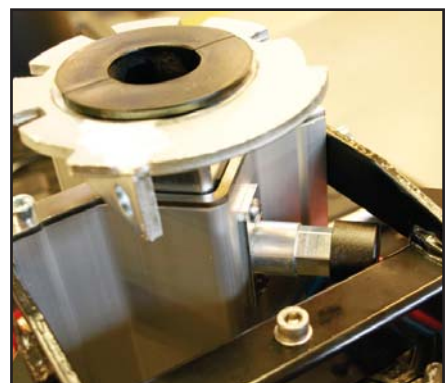

*Release button pressed out. Now the seat tube can be moved up/down to the height you wish. Press the release button again and make sure it is fitted in one of the 5 holes in the seat tube.*

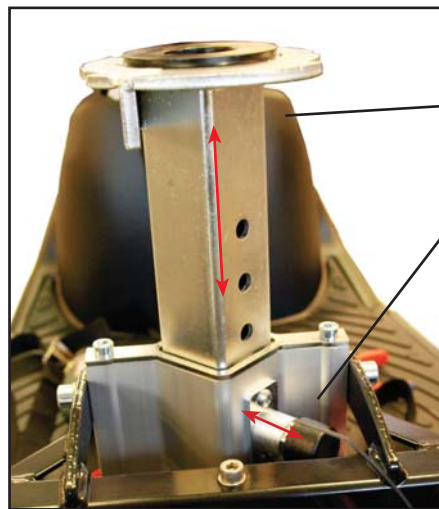

Seat tube

Release

Seat tube in top position. There are five holes for adjusting the seat tube. The release must be in a hole for the seat to be stable.

---

## Electric seat adjustment

The Mini Crosser can be fitted with electric seat adjustment as an optional extra.

To raise the seat, press the switch up. To lower the seat, press the switch down. If the switch is released, the seat will stop automatically. (See figure below.)

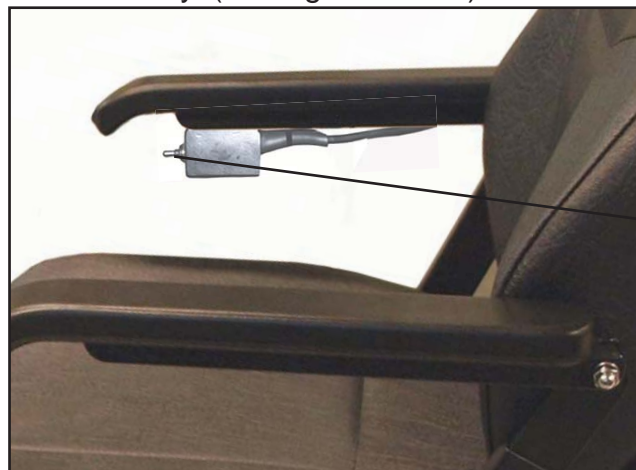

Switch for electric seat adjustment

Electric seat adjustment. If the switch is pressed up, the seat is raised. If the switch is pressed down, the seat is lowered.

## Seat rotation

Pull the release lever back. The seat can be rotated 90° to either side. When the lever is released, it engages with the seat and holds it in place at 45° intervals.

Other seats that can be supplied for the Mini Crosser work on similar principles. The release lever is normally mounted on the right, but can be put on the left if so wished.

### IMPORTANT!



The Mini Crosser is most stable when the seat is in its lowest position. Always drive carefully when the seat is raised. Never use the seat adjustment when driving on an uneven surface or in hilly terrain.



Take extra care when lowering the seat on a Mini Crosser using electric seat adjustment. Make sure that nothing is trapped in the space between the seat and the chassis.

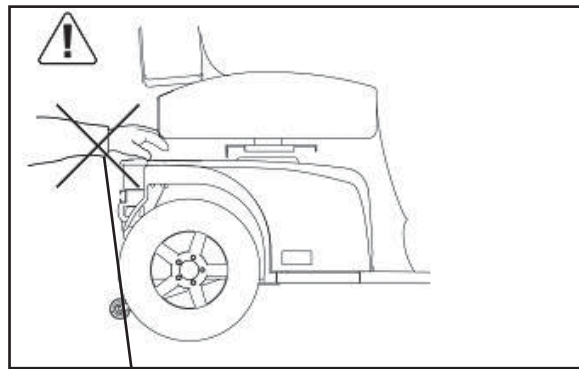

*Avoid trapping anything when lowering the seat.*



*Release lever for seat rotation. Release lever for seat forward/back.*

## Steering column

Can be adjusted forward/back with the release lever. Pull down on the lever and pull the handlebars closer for a good driving position. Use the lever again and push the steering column forward to make it easier to get out.

The height of the steering column can be adjusted approx. 11 cm up/down. First remove the rubber plug covering the Allen screw. Adjust the height using a 4 mm Allen key.

This applies to both the 3W and the 4W model. Remember to retighten properly after adjusting.



Adjusting the height of the handlebars. Applies to both the 3W and the 4W model.

*Lever for adjusting the angle of the handlebars*

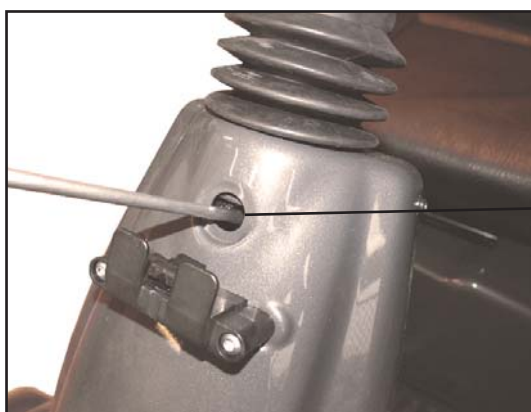

Adjusting the height of the handlebars. Applies to both the 3W and the 4W model.

*Allen screw for height adjustment*

## Serial number

All vehicles have a serial number plate showing the year of production and serial number. The same serial number can also be found on the front of the User Manual.

Please quote this number when making inquiries about servicing, spare parts, etc.

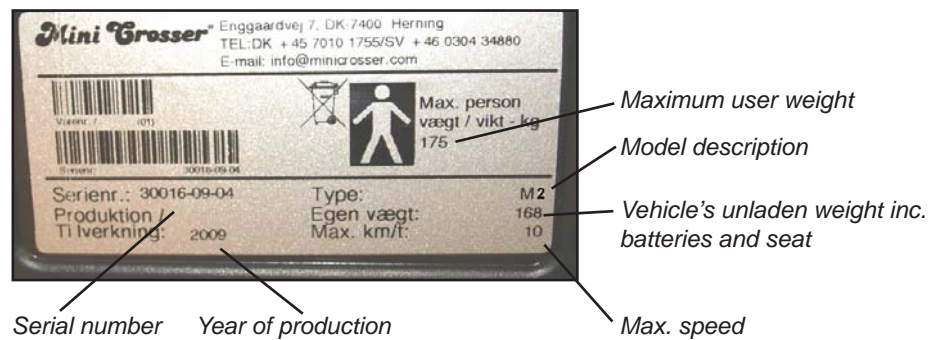

Position of serial number plate on vehicle.

## Driving the Mini Crosser M<sup>2</sup>

### Getting in and out

It is important to learn a safe technique for getting in and out of the Mini Crosser.

In general the following method should be followed:

- Make sure that the Mini Crosser M<sup>2</sup> is off (switch turned to 0) when getting in and out, otherwise the Mini Crosser could start if the accelerator was touched inadvertently.
- Make sure that the brake is on. (Lever for disengaging motor in top position.)
- Put the steering column in vertical position.
- If necessary, turn the seat through 45° or 90° and make sure that it is locked in position (clicked into place).
- If necessary, raise the armrest.

For some users the assistance of an attendant can be recommended. The attendant should:

- Take care not to injure him/herself when lifting/lowering/supporting the user.
- Make sure that the Mini Crosser is stable and unable to move. Turn off the Mini Crosser and check that the brake is on and the seat has been rotated until it clicks into place at either 45° or 90°.
- Make sure that the seat the user is being moved to is stable.



### **IMPORTANT!**

The Mini Crosser will turn itself off automatically after it has been stationary for 10 minutes even if the key has been turned to driving position.

To restart the vehicle, the key must be turned to stop position (0) and then to driving position (1).



*Turn the Mini Crosser off, return the steering column to upright position, rotate the seat and raise the armrest.*

## Braking systems

There are three braking systems on the Mini Crosser:

- Motor brake - adjusts vehicle speed also when going downhill.
- Magnetic brake - the magnetic brake is automatic and engages when the Mini Crosser stops. In an emergency, the Mini Crosser can be stopped instantaneously by turning the key switch. Please note that this will cause very sharp braking. The brake must never be disengaged mechanically using the disengagement lever on a slope. This function is only designed for use when pushing the Mini Crosser on a flat road.
- Electric safety brake - if the brake is somehow disengaged on a slope/hill, the Mini Crosser will brake automatically when it reaches a certain speed. There is an electric safety feature in the control system, which works even if the battery is disconnected. This is also the reason why the Mini Crosser cannot be towed at more than 5 km/h. See the section about towing.
- Handbrake - intended as an emergency brake and parking brake. It must be operated with caution when driving in slippery conditions and downhill.

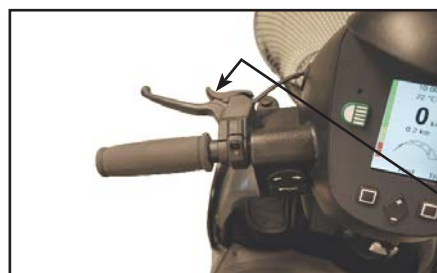

*When using the handbrake as a parking brake, lock it in braking position by pressing the button in while applying the brake.  
To release the brake, press the button again.*

*Handbrake lock*

## General safety advice

Make sure that the backrest is upright and the seat is as low as possible.

Positioning belts are recommended if the user is unable to maintain a good driving posture independently.

Adjust your driving to road conditions. Take account of light, traffic and weather. Be particularly careful when driving in the

dark or in bad weather, such as rain or snow. Avoid driving on gradients with poor surfaces, such as: snow, ice, new-mown grass, wet grass and wet leaves.



Never drive when under the influence. This applies not only to alcohol, but also to drugs and medicines.  
Reduce speed immediately if you feel you are losing control.

Always use the indicators when changing direction.

Check that lights and indicators are working before driving off.  
Use your lights when driving after lighting-up time.

As far as possible, grip the handlebars firmly with both hands.



Take care not to have anything in the basket at the front that might inadvertently operate the accelerator.



**WARNING!** Do not lower the handlebars so far that the accelerator can hit you on the leg when you turn the vehicle and so be operated in advertently. If the handlebars need to be very low, a twist grip accelerator is recommended. This is particularly relevant if leg supports are being used.



**ALWAYS** switch the scooter off when it is not in use. Turn the key to 0.

## Driving

Even though the Mini Crosser is very stable, it can tip over. Avoid sudden changes of speed and direction when travelling at high speed, on poor surfaces and, not least, on slopes.

For short distances the Mini Crosser can drive up steeper gradients than it has been tested as dynamically stable for. The same applies to driving down such gradients. In such cases there is an increased risk of the Mini Crosser tilting and even tipping over. So be extra careful in following the driving tips given below.

Anti-tilt wheels are recommended for driving in very hilly terrain. (Optional extra)

New users are urged to practise the following in an area where there is no other traffic:

- Set the Mini Crosser to low speed. Drive forwards and backwards. Gradually turn the speed selector up and feel the change in the speed of the Mini Crosser.
- Practise starting and braking. Get used to the Mini Crosser's response time.
- Practise driving in a narrow space, similar to inside a shop or through a door.
- Practise turning, and get a sense of how much space is required. Always drive slowly when turning. Practise reversing too.
- Practise cornering and driving over obstacles and on slopes. Always drive straight up/down kerbs and ramps. Never at an angle. See the illustrations on the following pages.
- Try braking at different speeds and notice the stopping distances.
- If possible, try driving on different surfaces (road, grass and gravel).
- Practise assessing how far you can drive on a single battery charge. Note how quickly the battery indicator changes from green to amber to red.



**Note!**

The driving distance of the scooter will be reduced when driving in hilly districts, into a head wind, in cold weather and with low tyre pressure.

**Traffic regulations**

The traffic legislation for scooters varies from country to country. Before starting to use the vehicle outdoors, it is the user's responsibility to familiarise him/herself with the relevant legislation.

**The following rules apply in Denmark:**

Mobility vehicles such as the Mini Crosser with a maximum speed of up to 15 km/h count as cycles in traffic legislation and the traffic regulations for cycles must be followed at speeds in excess of 6 km/h.

At speeds of up to 6 km/h the Mini Crosser is regarded as a “pedestrian”, and it is permissible to travel on the pavement at this speed. “Tortoise” speed corresponds to approx. 6 km/h. Lights must only be used during lighting-up time. Crash helmet and seat belts are not compulsory.

### **Electromagnetic compatibility**



If the Mini Crosser starts making involuntary movements or if the brakes are released, turn the Mini Crosser off as soon as it is safe to do so. In certain circumstances a Mini Crosser can set off shop alarms.

The Mini Crosser satisfies the requirements for the use of scooters in an environment with electromagnetic noise. There may, however, be rare situations in which electromagnetic noise can affect the Mini Crosser. Sources of such noise include radio and television stations, amateur radio transmitters and mobile phones.

If such equipment is being used close by, it is recommended that the Mini Crosser is switched off. Mobile phones should not be used while driving.

### **When driving in traffic...**

Be particularly aware of the following when driving in traffic:

- The Mini Crosser is a low vehicle and not always easy for other road users to see. Make quite sure that other road users have seen you before driving onto the highway.
- Keep an eye on traffic behind you. Keep well over to the side of the road when driving on busy roads.
- Turning right and left at crossroads. Be aware of cyclists and pedestrians. Follow the rules of the road for cyclists.
- How quickly things are happening. How long do the lights stay green? How quickly are cars approaching? etc.

## Specific driving situations

### Up kerbs

- Stop at right angles to the kerbstone about 5-10 cm away from it. Keep an eye on other road users.
- Lean forwards.
- Accelerate moderately so that your vehicle can overcome the obstacle. Do not stop halfway, but reduce speed once the vehicle is up.
- If the kerb is too high, do not try again, but find an alternative route.



### Down kerbs

- Lean back.
- If you are driving onto a road with traffic, keep an eye on other road users.
- Drive forwards and down the kerb at low speed. Make sure that your anti-tilt wheels (if fitted) do not catch on the edge.

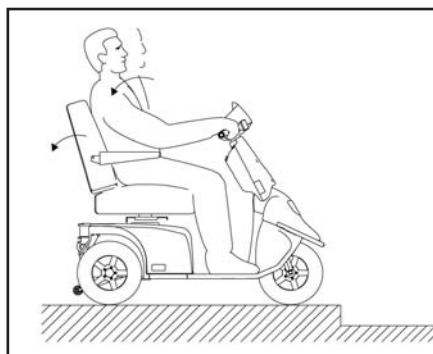

## Up a ramp/hill

- There is a risk of tipping over backwards if the seat is pushed back when you start driving up a slope, e.g. a ramp.
- Pull the seat forward! Check that any ramp is stable.
- Lean forwards.
- Accelerate moderately so that your vehicle can overcome the obstacle. Do not stop halfway. Reduce speed once the vehicle is up. If you need to start on a hill, accelerate slowly so as not to tip over backwards.

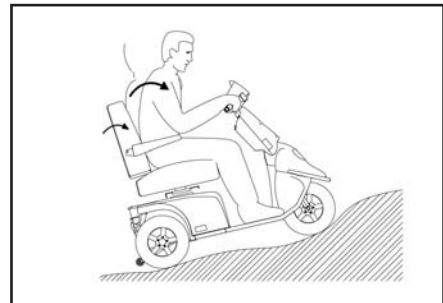
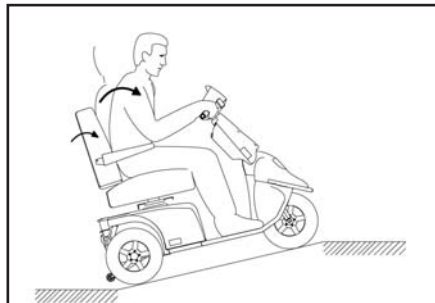

## Down a ramp/hill

- Check that any ramp is stable.
- Lean back.
- Drive slowly down. Avoid stopping midway on short, steep slopes. On long hills, it is advisable to stop every now and again if you feel your speed is getting too high.

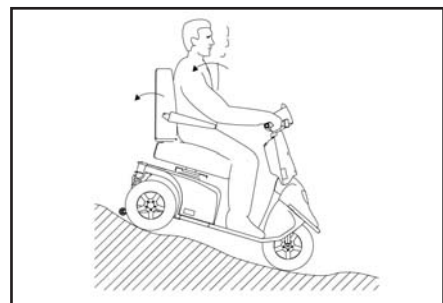
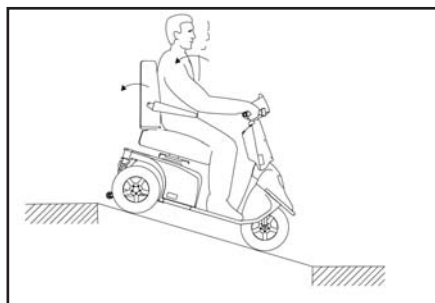

### **Across a slope**

- Lean into the slope.
  - Avoid sudden and sharp movements. This is particularly relevant when reversing.
  - Always drive at low speed.
- 

### **Long hills/difficult ground**

The Mini Crosser is at risk of overheating on very long and steep hills or on very soft ground, possibly also combined with high user weight.

To protect the Mini Crosser motor from overheating, there is a built-in thermoswitch, which initially sets the Mini Crosser to half speed.

However, if you carry on moving over difficult ground, the Mini Crosser will at some stage stop completely, and the battery indicator will flash with 6 lamps. The Mini Crosser must be left to cool down for 3-5 minutes before it can start again.

To reset the fault, switch off the Mini Crosser then turn it on again.

If the Mini Crosser has not had long enough to cool down when it is restarted, it will initially only run at half speed.

**Note:**

The situation described above will never happen in normal use. It only happens if the conditions are extremely challenging.

## Anti-tilt wheels / stabilisers

The Mini Crosser is a very stable vehicle. HOWEVER, in the case of incorrect weight distribution or careless driving there is a risk of tipping over.

We therefore recommend fitting anti-tilt wheels in such circumstances. (See picture below)

(Anti-tilt wheels / stabilisers are optional extras.)



*Anti-tilt wheels*

## General care and maintenance

A Mini Crosser M<sup>2</sup> does not require much maintenance. It should be kept in a generally good condition, however. The following should be checked regularly:

- Tyre pressure (if pneumatic tyres are fitted)
- Tyre wear
- Keep the control panel, the charging socket and the electronics box under the seat dry.
- Battery charging



Never wash the Mini Crosser with a high-pressure cleaner or direct water jet! This could damage the Mini Crosser's electronics.

To keep the Mini Crosser in good condition safety-wise, we recommend the following regular checks:

### Daily:

- Test the indicators and driving lights before using the Mini Crosser in the dark or poor visibility.

### Every three months:

Test the brakes and motor disengagement

With the disengagement lever up, it must not be possible to push the Mini Crosser.

Test the brake disengagement function

When the brake disengagement lever is down, the battery indicator should flash to show an error if the Mini Crosser is turned on. In this case the Mini Crosser must not be able to move when the accelerator is activated.

Test the handbrake.

Apply the handbrake for a couple of seconds at low speed. This will ensure that the lever arm and brake shoes do not seize up.

Lubricate the lever arm on the brake hub with acid-free oil - left-hand rear wheel.

### Annual

The Mini Crosser M<sup>2</sup> is designed for safe travel for at least 10 years, up to a max. of 5,000 hours, provided it is serviced and safety-checked every year, corresponding to 500 hours of operation. The service must be carried out by an authorised workshop.



**IMPORTANT!** For safety reasons it is of the utmost importance that the servicing and safety check intervals are complied with, as this minimises the risk of brake failure and short-circuits in the wiring, which could generate heat and cause a fire.

(For further information see the Service Manual.)

---

## **Insurance**

In the eyes of the law a Mini Crosser M<sup>2</sup> with a maximum speed of 15 km/h is a cycle, so separate insurance is not required.

Most contents/home insurance policies include third-party liability insurance for cyclists and so also cover Mini Crosser M<sup>2</sup> users.

We recommend that you talk to your insurance company about this when the vehicle is delivered.

If necessary, comprehensive insurance will have to be taken out separately.

## Batteries

The Mini Crosser uses sealed, maintenance-free GEL batteries (Exide 12 V/56 Ah or AGM 12 V/71 Ah).

They do not generate gas and do not have to be topped up with water.

---

## Charging



Please NOTE that the Mini Crosser can be equipped with several types of charger (ask your dealer for information on the various types).



**IMPORTANT!** Only ever use a charger designed for charging dry maintenance-free batteries. The max. charging current is 12 A.

If charging is to take place outdoors, an enclosed charger without a fan should be chosen.

The battery manufacturer recommends charging the batteries at temperatures between +10° and +30°C in order to achieve the charging times specified in “Technical data”.

Charging will take longer at temperatures below +20°C. This is because the battery finds it more difficult chemically to absorb the current.



Please NOTE that the capacity of the batteries will reduce over time and at low temperatures. In practice this means that vehicles with old batteries have a shorter driving distance than they had when the batteries were new.

Battery capacity at -10°C is about half the equivalent capacity at +20°C.



### **Note!**

The Mini Crosser uses a little power even when it is turned off and the key is turned to 0. It is therefore recommended to connect it to the charger whenever it is not used.

Avoid draining the batteries completely. We recommend charging the batteries in a heated room. If it is not possible to do this every day, it is a good idea to charge the Mini Crosser in a heated room (approx. 20°C) once a week.

New batteries do not reach full capacity until they have been charged and discharged about 20 times.



It is **IMPORTANT** to fit the batteries correctly. The battery terminals and snap locks are marked +/- . They must be fitted as shown in the sketch below. Make sure that the snap locks are properly closed. For the same reason there must not be any burrs on the terminals.

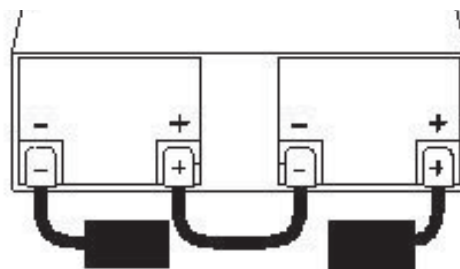

The Mini Crosser should be charged while not in use. The charger supplied from the factory switches over to trickle charging (very low power consumption) automatically when the batteries are fully charged. You can therefore leave the charger connected until the Mini Crosser is next used. The charger cannot overcharge the batteries.

The charger will flash until charging is complete. Then it will show a steady light.



The charger must not be placed on the seat during charging.



**IMPORTANT!** Never use charging devices other than those supplied from the factory without first contacting the dealer.

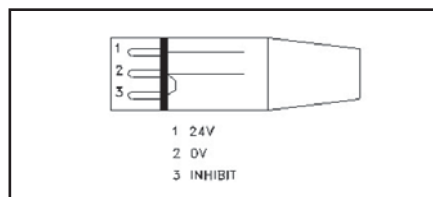

*NEUTRIK NC3MX charging plug*



*Connect the charging plug to the 3-pin socket on the steering column. The charging socket is located under the protective cover.*

## Battery disposal

Used batteries must be disposed of through your supplier or at a recycling centre.

Take care when handling leaky batteries, as the gel contains corrosive acid.

### INFO!

New batteries can be purchased from Medema Danmark A/S.

---

## Storage

The scooter should be stored and charged under cover, preferably at temperatures above 0°C.

### Note!



The charger must be kept dry, but should not be covered when in use.

In the case of long-term storage we recommend covering the Mini Crosser M to protect it from dust, rain and sunlight.

---

## Cleaning

Clean the Mini Crosser M<sup>2</sup> with a damp cloth. If necessary, wipe dry with a chamois leather.

Wipe the covers dry and polish with car wax.



**IMPORTANT!** Never use a high-pressure cleaner or hose, as it could damage the Mini Crosser's electronics.

---

## Changing the wheels

If you get a puncture in one of the pneumatic tyres or if a tyre is so badly worn that it needs to be replaced, follow the instructions below.

Tyres and inner tubes can be purchased from the authorised dealer who supplied the Mini Crosser.

The Mini Crosser must be **TURNED OFF** before you start.



### Changing the wheels on the 4W model

5 mm Allen key

- Undo the five bolts.
- Take the wheel off.
- When the wheel is put back on, the spring washers must be refitted between the wheel rim and bolts.



### REMEMBER!

- to let all the air out before taking the wheel apart to repair a puncture
- to secure the bolts with spring washers

The bolts must be done up tightly.



### Changing the wheels on the 3W model

Rear wheels: Take off in the same way as described above.

Front wheel:  
17 mm fork spanner  
6 mm Allen key  
5 mm Allen key

Remove the mounting bolts with a fork spanner and Allen key.

Take the wheel off in the same way as the back wheel using a 5 mm Allen key.



#### REMEMBER!

- to let all the air out before taking the wheel apart to repair a puncture
- to secure the bolts with spring washers

## Fuses

### The Mini Crosser has the following protection systems:

- As a safeguard against overheating There are two switches are integrated in the engine. By incipient overheating speed is reduced to half power, and by prolonged overheating the scooter will stop. After cooling for 3 to 5 minutes, the scooter is able to reach full speed and traction.
- The control fuse protects against mains faults. It is located under the rear cover.
- The main fuse protects against short-circuits in the main current circuit. The fuses are located under the rear cover behind the batteries. Fuse type DIN 2581 - 100A.
- If the ignition key is turned at the same time as the accelerator is operated, the vehicle will not move off for safety reasons.
- The lights and horn are protected by electronic fuses, which protect against any short-circuiting that may occur. To prevent accidental short-circuiting when a bulb is changed, the Mini Crosser must be turned off when the new bulb is fitted and then turned on again afterwards.

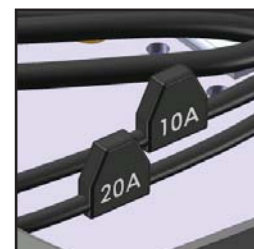
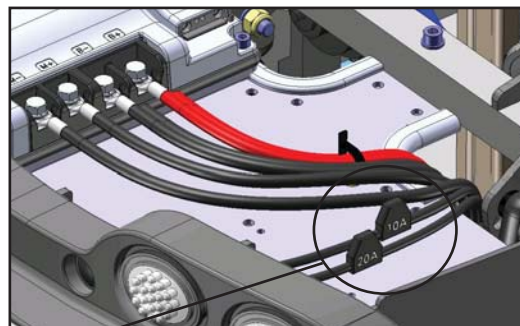

*Take the rear cover off. The plastic cover can be removed by squeezing the sides. Now the fuses can be replaced.*

## Brakes

There are three braking systems on the Mini Crosser M:

- Motor brake
  - Magnetic brake
  - Handbrake
- 
- Motor brake: adjusts vehicle speed also when going downhill.
  - Magnetic brake: automatic and comes on when accelerator is released. It also acts as a parking brake when the Mini Crosser is at a standstill.  
In an emergency, the Mini Crosser can be stopped instantaneously by turning the key switch. Please note that this will cause very sharp braking. The rear wheels will lock!  
Must not be used in the normal course of driving!
  - Electric safety brake - if the brake is somehow disengaged on a slope/hill, the Mini Crosser will brake automatically when it reaches a certain speed. There is an electric safety feature in the control system, which works even if the battery is disconnected. This is also the reason why the Mini Crosser cannot be towed at more than 5 km/h. See the section about towing.
  - Handbrake: intended as an emergency brake and parking brake. It must be operated with caution when driving in slippery conditions and downhill.

## Disengagement

- Turn the key to (0) position.
- Push the disengagement lever at the back down.  
The motor brake is now disengaged and the vehicle can be pushed or towed, but not driven.

### NOTE!



**The motor brake must never be disengaged on sloping terrain.**

if the brake is somehow disengaged on a slope/hill, the Mini Crosser will brake automatically when it reaches a certain speed. There is an electric safety feature in the control system, which works even if the battery is disconnected. This is also the reason why the Mini Crosser cannot be towed at more than 5 km/h. See the section about towing.



**Once the motor brake has been disengaged, the Mini Crosser can only be braked with the hand brake.**



*Push the disengagement lever down to disengage (only handbrake works) and push up to reactivate the motor (normal driving now possible).*

*Disengagement lever*

---

## Transporting by motor vehicle

The Mini Crosser must always be restrained and the handbrake locked during transport in a motor vehicle or trailer.

Avoid lifting by the seat, covers, handlebars and armrests

If you just need to lift the scooter slightly, take hold of it between the rear lights and by the front bumper.

Secure it in the vehicle with belts attached to the two eyes at the front and two at the back. All the eyes are marked in yellow. See the section entitled “Securing to vehicle floor with belts”.

## Securing to vehicle floor with belts

Dahl Engineering belt set for securing in motor vehicles. Item No. C2-0242

ALWAYS use four belts at the back and two at the front.

The belts must always be attached to approved fittings in the vehicle and the four eyes welded to the scooter.

The belts MUST be attached within the angles shown in the picture for optimum security.



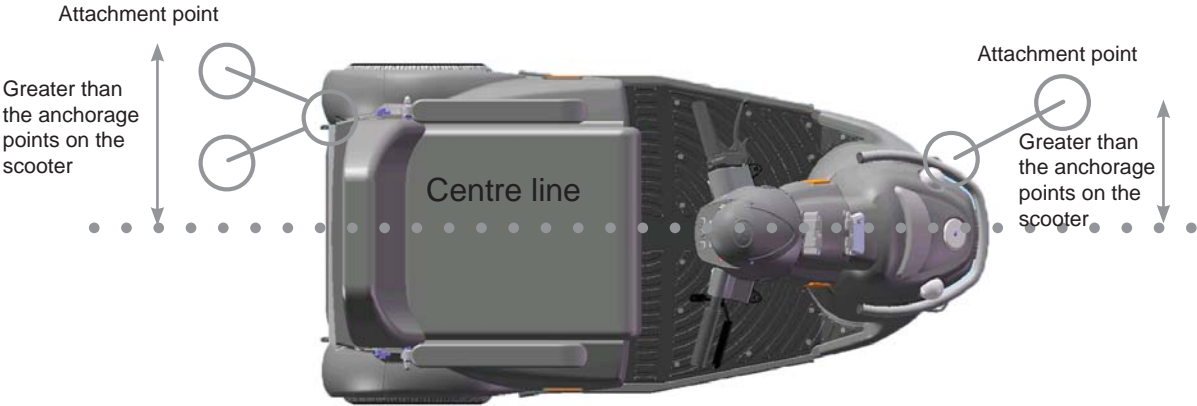

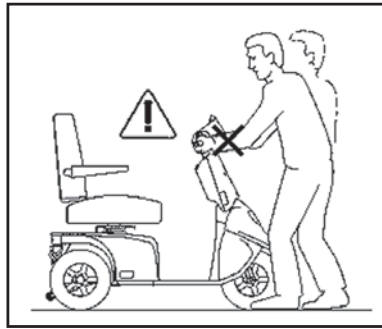

For transport in an estate car, the seat can be lifted off and the handlebars folded down. This reduces the maximum height to 69 cm.

The Mini Crosser can be used as a seat during transport in a van or bus, provided it is securely anchored to the vehicle with approved four-point belts attached to the restraint points provided on the Mini Crosser.

The Mini Crosser's restraint points have been tested and approved in accordance with ISO 7176-19.

The user must also always be independently restrained in the actual motor vehicle in accordance with traffic legislation rules.

### Example

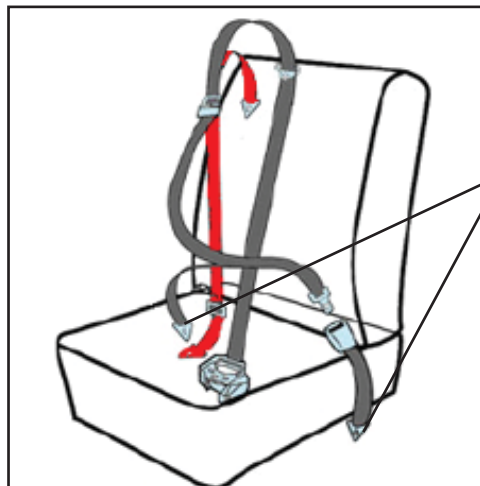

#### Restraining the passenger with a static 3-point seat belt:

Secure to the rearmost retractors.

The shoulder belt must rest against the collar bone and fall diagonally to the hip, where it is secured.

Tighten the belt by pulling on the loose strap. Undo it again by lifting the buckle. This is the same as on an aircraft.



Retractor with belt



Male and female parts of belt done up



Remember to turn the Mini Crosser off during transport. Turn the key to 0.

However, if at all possible, we recommend that the user occupies one of the seats in the motor vehicle. All other things being equal, this is safer.

---

## Transporting by plane

If the Mini Crosser is to be transported by plane, the airlines require:

- the batteries to be flight-approved
- the air to be let out of the tyres
- the battery leads to be disconnected (not always, but frequently)

The seat and cover have to be removed to disconnect the battery leads.

A battery declaration for air travel can be found on the Mini Crosser website:

[http://www.minicrosser.dk/Download\\_brochurer.asp](http://www.minicrosser.dk/Download_brochurer.asp)

---

## Towing

If you should be unfortunate enough to break down, the Mini Crosser can be towed or pushed. The Mini Crosser must always be turned off and the motor brake disengaged during towing. See the section on Brakes.



If the Mini Crosser is to be towed, secure a rope to the tow fitting on the front - marked with a yellow "hook mark". Do not tow faster than 5 km/h. The scooter will generate electricity when it is towed, with the motor acting as a dynamo. If it is towed at more than 5 km/h, there is a risk of the motor generating enough electricity to damage the scooter and, in the worst case, cause a fire.

The Mini Crosser will try to brake if it is towed at more than 5 km/h.

---

## Dimensioned drawing, Mini Crosser M<sup>2</sup> 3W

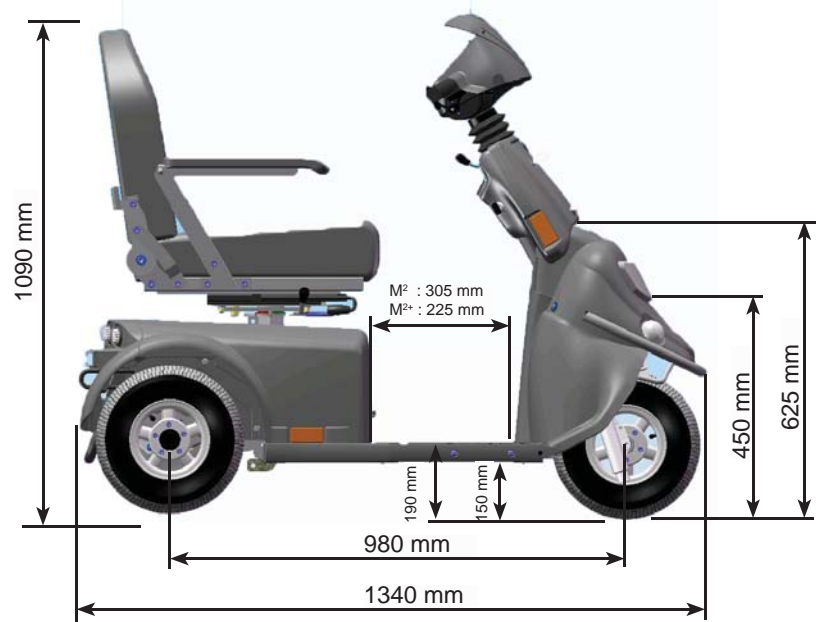

M<sup>2+</sup> : Equipped with extra large batteries, the footspace will be reused.

## Dimensioned drawing, Mini Crosser M<sup>2</sup> 4W

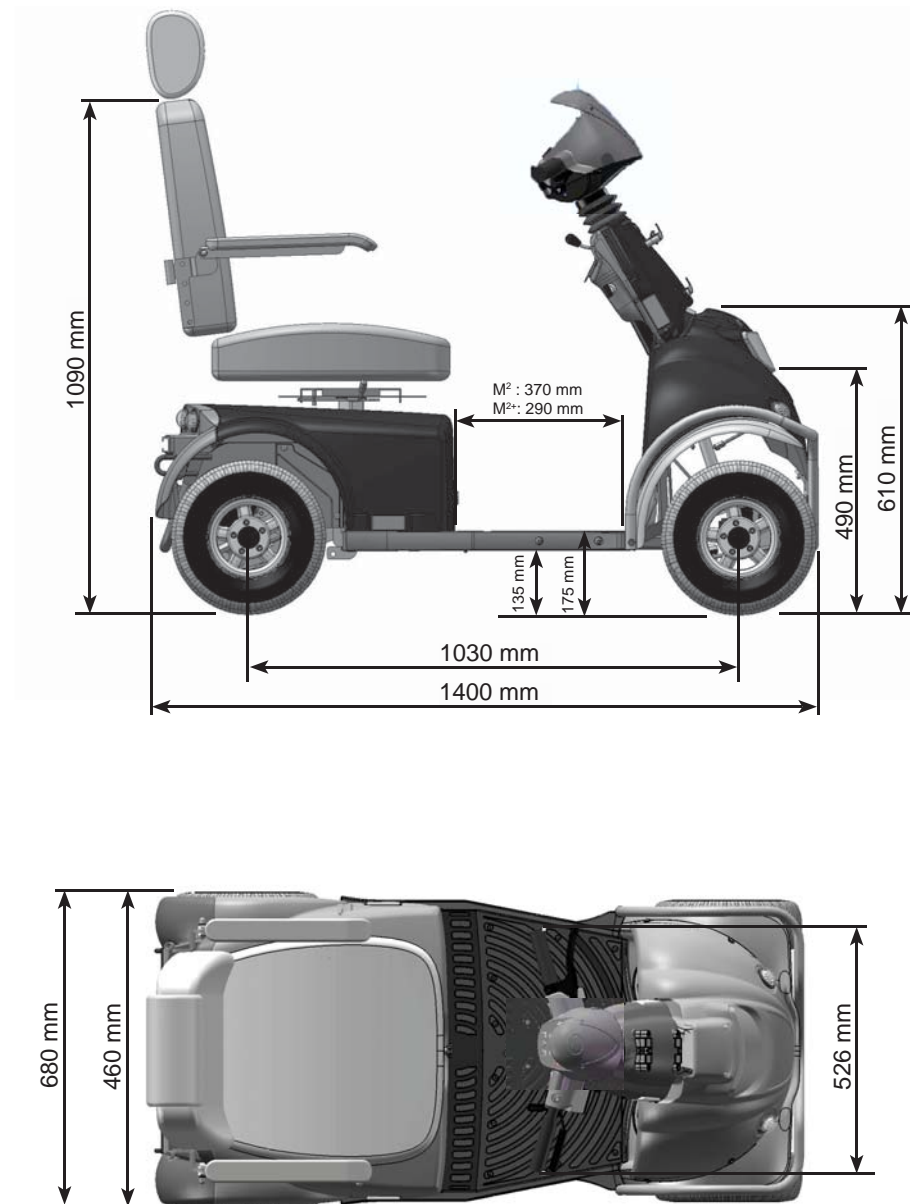

M<sup>2+</sup> : Equipped with extra large batteries, the footspace will be reduced.

## Introduction to seats - Ergo Standard



### Lever for seat rotation

Pull the lever back to release the seat. The seat can then be turned 90° to either side with a stop every 45°.

The lever is spring-loaded and the seat locks automatically when the lever is released.

This lever is located on the right as standard, but can also be put on the left.



### Lever for seat forward/back

Pull the lever out/up to release the seat on the slide rail. The seat can then be moved forward or back as required.

When the lever is released, the seat automatically locks at the nearest stop.

There is a chock block on the front and back of the slide rail.



### Adjusting the angle of the armrest

The adjusting screw makes it possible to alter the angle of the armrest by about 15°.

The arm can be folded right up to make it easier to get in and out.

(Height adjustment of the armrest is an optional extra.)



### **Adjusting the angle of the backrest**

The angle of the backrest can be adjusted by about 30°. This can be done by undoing the adjusting screw and changing the position of the spacer. Do the screw up again after making the adjustment.

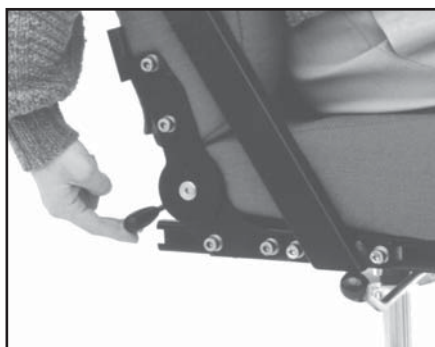

### **Optional extra:**

The seat can be fitted with a gas cylinder for adjusting the angle of the backrest.

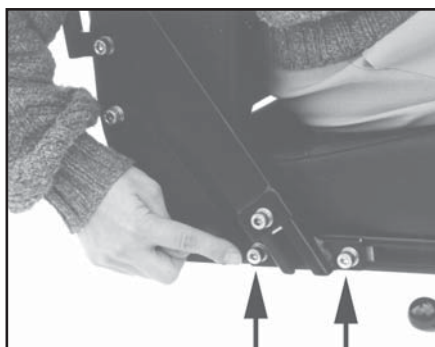

### **Armrest forward / back:**

The armrest can be moved forward / back on the C-rail. This can be done by undoing the screws indicated. Do the screws up again after making the adjustment.

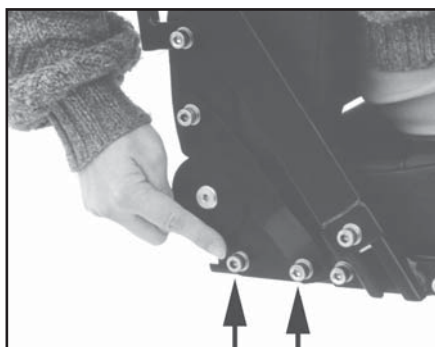

### **Backrest forward / back:**

The depth of the seat can be adjusted. This can be done by moving the backrest forward and back while the seat cushion is held in position. Undo the screws indicated on both sides. The backrest can then be moved as far back as

the edge of the rail and about 15 cm forward. Do the screws up after making the adjustment. The screws must be at least 2 cm from the end of the C-rail.

## Introduction to seats - Mando



### Adjusting the angle of the backrest:

The angle of the backrest can be adjusted by about 30° by raising this lever.



### Adjusting the angle of the armrest:

The angle of the armrest can be adjusted by turning this screw.



### Adjusting the height of the armrest:

The armrest can be raised/ lowered by undoing the two screws and moving the bracket one hole up or down.

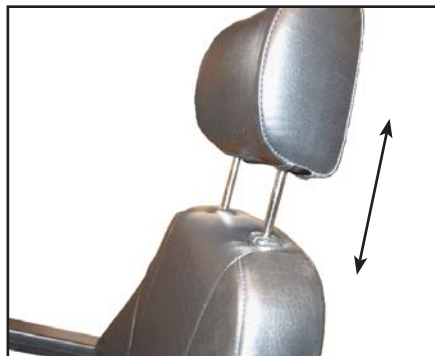

### Headrest:

The headrest can be raised and lowered steplessly.

## Troubleshooting

The following is a list of various problems that, in our experience, may occur. The list gives possible causes and remedies.

Problem	Possible causes	Remedy
<p>The Mini Crosser will not go.</p> <p>The battery indicator is not lit.</p>	<p>The key has not been turned to start.</p> <p>The batteries are completely flat.</p> <p>The control fuse has blown.</p> <p>The main fuses have blown.</p>	<p>Turn the key and wait 5 sec. before activating the accelerator.</p> <p>Charge the batteries.</p> <p>Change the fuse.</p> <p>Contact supplier.</p>
<p>The Mini Crosser will not go, but the battery indicator is lit.</p>	<p>The Mini Crosser has been overloaded.</p> <p>The handbrake is on.</p> <p>There is a fault in the electronics.</p> <p>The batteries are flat.</p> <p>The charging plug has not been removed.</p>	<p>Wait approx. 1 min. before trying again. The vehicle must be turned off (<a href="#">see section on Fuses</a>).</p> <p>Release the handbrake.</p> <p>Contact supplier.</p> <p>Contact supplier.</p> <p>Remove the charging plug.</p>
<p>The driving speed is too low.</p>	<p>The speed selector is on slow.</p> <p>The electronics are overloaded.</p> <p>There is too little air in the tyres.</p>	<p>Change to a faster speed.</p> <p>Stop and wait 3-5 minutes before starting.</p> <p>Pump the tyres up to the right pressure.</p>
<p>The driving distance per charge is too short.</p>	<p>There is a problem with the batteries.</p> <p>Low temperature.</p> <p>There is a problem with the charger.</p> <p>There is too little air in the tyres.</p> <p>The charging method is wrong.</p>	<p>Charge the batteries and check that the green lamp on the charger lights up before driving off.</p> <p>Contact supplier.</p> <p>Pump the tyres up to the right pressure.</p> <p>Read the section on <a href="#">Charging</a> in the User Manual.</p>
<p>The charging lamp on the charger does not light up when the charger is connected to the mains and the Mini Crosser.</p>	<p>No power to the switch.</p> <p>Fault in cable.</p> <p>Fault in charger.</p>	<p>Turn the switch on.</p> <p>Contact supplier.</p> <p>Read the operating instructions for the charger.</p> <p>Contact supplier.</p>
<p>The "ready" lamp on the charger does not light up even though the charger has been on for 10-12 hours.</p>	<p>There has been a power cut.</p> <p>The charger is doing a top-up charge.</p> <p>There is a problem with the batteries.</p> <p>There is a fault in the charging plug for the Mini Crosser M<sup>2</sup>.</p>	<p>Reconnect the charger and repeat the charging process.</p> <p>Check again half an hour later.</p> <p>Contact supplier.</p> <p>Push the charging plug all the way in and repeat the charging process. Read the operating instructions for the charger.</p>

<b>Problem</b>	<b>Possible causes</b>	<b>Remedy</b>
The "ready" lamp on the charger lights up even when partly discharged batteries are connected.	The fuse in the charger has blown. The switch in the charging plug is malfunctioning.	Contact supplier.  Contact suppliers - read the operating instructions for the charger.
The charger lamp is showing an error.	The charging plug has not been inserted or there is a mains fault. The battery voltage is too low for charging to start.	Push the charger plug in or contact the supplier.  Read the operating instructions for the charger - or contact the supplier.
Thermometer symbol is half-red and flashes. The scooter is running at half speed.	The motor is overheating and has reached the limit of when the first safety switch responds.	Immediately pull over at a safe distance from other traffic and stop the Mini Crosser. Wait until the temperature icon disappears, ca. 3-5 min. Turn the Mini Crosser off and on again to continue at full speed.
Thermometer symbol is red and alluminated. The scooter has stopped.	The motor is overheating and has reached the limit for when the security swithc shuts the motor off completely.	If the Mini Crosser has stopped at an inappropriate place in traffic, turn on the emergency lights. If possible disengage the scooter and push it away from traffic. Let Mini Crosser cool until the temperature icon disappears - approx. 3-5 min. Turn the Mini Crosser off and on again. Now it can run normally again.
Mini Crosser can not remember the time.	Battery on main circuit board has run out of power.	Contact service technician.

If there is an electronic fault, a number of lamps in the battery indicator will light up. The following table shows what they mean.

Lamps	Causes	Remedy
1 lamp	The batteries need charging or the connection to a battery is poor.	Check all connections between the controller and batteries. If these are fine, try charging the batteries
2 lamps	Poor connection to the motor.	Check the connection between the motor and controller. Contact supplier.
3 lamps	Short-circuit between the motor and a battery connection.	Contact supplier - say how many lamps are lit.
4 lamps	Not in use	
5 lamps	Not in use	
6 lamps	Not in use	
7 lamps	Accelerator fault.	Contact supplier.
8 lamps	Controller fault.	Contact supplier.
9 lamps	Poor connection to motor brake. Magnetic brake is disengaged.	Check the connections from brake to controller, or push the brake lever up. Check that the vehicle is not disengaged.
10 lamps	The controller has been supplied with a high voltage in excess of 38 V. Usually seen in the case of a poor connection.	Check all connections from the batteries to the controller.
Running lights	Charger is connected. Remove charger.	Remove charger.
Running lights from the center and out.	The accelerator has been activated during start up.	Turn the key back to 0 and to 1 to reset the fault.

## Programming



**NOTE!** For safety reasons, modifications may only be made by trained personnel, such as Mini Crosser service engineers and consultants or authorised service personnel at mobility centres, etc.

## Technical data

	M <sup>2</sup> 3W	M <sup>2</sup> 4W
<b>General information:</b>		
Transport height without seat (Steering column folded down)	69 cm	69 cm
Total length: Total length incl. anti-tilt wheel: Total width:	134 cm 143 cm 68 cm	140 cm 148,5 cm 68 cm
Total weight incl. batteries and Ergo Std seat.	151 kg	168 kg
Weight without seat (Ergo Standard 45 cm).	130 kg	147 kg
Static stability in all directions	15° - 26%	15° - 26%
Dynamic stability in all directions at minimum speed	10° - 17%	10° - 17%
Climbing ability with person weighing 175 kg	15° - 25%	17° - 30%
Kerb climbing	12 cm	12 cm
Max. speed	15 km/h	15 km/h
Braking distance 10 km/h 15 km/h	2.0 metres 3.5 metres	2.0 metres 3.5 metres
Control	S-180	S-180
KW transaxle	0,7 kW	0,7 kW
Turning radius	105 cm	141 cm
Max user weight - standard	175 kg	175 kg
Max user weight inc. accessories HD version.	-----	250 kg
Tyre dimensions (6 ply)	3.00-6 max. outside diameter 340 mm	3.00-6 max. outside diameter 340 mm
Tyre pressure	2.8 bar	2.8 bar
Classification, ISO	Class C	Class C
<b>Seats:</b>		
Effective seat width: Ergo Standard Spinalus Mando HD (user weight max 250 kg) Ergo child / junior	40,45,50,55,60 cm 40, 45, 50 cm 48 cm ----- 35, 37 cm	40,45,50,55,60 cm 40, 45, 50 cm 48 cm 60, 65, 70 cm 35, 37 cm
Effective seat depth: Ergo, Spinalus and HD seats Mando Ergo child / junior	32-52 cm 48 cm 20-30 and 25-40 cm	32-52 cm 48 cm 20-30 and 25-40 cm

	<b>M<sup>2</sup> 3W</b>	<b>M<sup>2</sup> 4W</b>
Seat back height: Ergo standrad / HD Spinalus Mando Ergo child / junior	48 cm 56 cm 53 cm 36-41 cm	48 cm 56 cm 53 cm 36-41 cm
Height: front edge of seat to ground Ergo Standard with slide rail Ergo Standard without slide rail Mando seat with slide rail Mando seat without slide rail	64 - 74 cm 61 - 71 cm 64 - 74 cm 61 - 71 cm	64 - 74 cm 61 - 71 cm 64 - 74 cm 61 - 61 cm
Height: footplate to front edge of seat Ergo Standard with slide rail Ergo Standard without slide rail Mando seat with slide rail Mando seat without slide rail	45 - 55 cm 41 - 51 cm 45 - 55 cm 41 - 51 cm	45 - 55 cm 41 - 51 cm 45 - 55 cm 41 - 51 cm
Angle of backrest Ergo standard / HD (manual) Ergo standard / HD (EL) Spinalus Mando Ergo child / junior	Approx. -5° to +20° Approx. -5° to +30° Approx. -5° to +20° Approx. +5° to +30° Approx. -5° to +20°	Approx. -5° to +20° Approx. -5° to +30° Approx. -5° to +20° Approx. +5° to +30° Approx. -5° to +20°
<b>Batteries:</b>		
56 Ah batteries	Standard	Standard
Maximum driving distance with new batteries at +20° on flat, firm surface	40 km	35 km
75/80 Ah batteries	Option	Option
Maximum driving distance with new batteries at +20° on flat, firm surface	60 km	55 km
110/115 Ah batteries	Option	Option
Maximum driving distance with new batteries at +20° on flat, firm surface	80 km	75 km
Optimum battery capacity is reached after approx. 20 charges / discharges.		
Battery type: Standard: Option: Option:	2 x 12 V / 56 Ah 2 x 12 V / 75 Ah 2 x 12 V / 110 Ah	2 x 12 V / 56 Ah 2 x 12 V / 75 Ah 2 x 12 V / 110 Ah
Max. battery dimensions in cm.	26.5 x 17 x 22 28.4 x 26.7 x 23	26.5 x 17 x 22 28.4 x 26.7 x 23
Battery weight, 2 batteries 56 Ah 75/80 Ah 110/115 Ah	43 kg 50 kg 80 kg	43 kg 50 kg 80 kg
Energy consumption in kWh, when charging from "empty" 56 Ah 75/80 Ah 110/115 Ah	Approx. 1.5 Approx. 1.5 Approx. 3.0	Approx. 1.5 Approx. 1.5 Approx. 3.0

---

	<b>M<sup>2</sup> 3W</b>	<b>M<sup>2</sup> 4W</b>
Charging device, 24 V DC 56 Ah 75 Ah 110 Ah	6 - 10 A 6 - 10 A 10 - 12 A	6 - 10 A 6 - 10 A 10 - 12 A
Approx. charging time at 20° C	8 hours	8 hours
<b>Lighting:</b>		
Bulb, headlight	24 V - 21 W	24 V - 21 W
Diode, rear light	24 V - 2 W	24 V - 2 W
Diode, indicator	24 V - 2 W	24 V - 2 W
Standard colour	Grey - metallic	Grey - metallic

The Mini Crosser has been tested for the requirements described in EN 12184, which are the basis for CE marking. That means that it has also been tested for the durability requirements (ISO 7176-8), fire safety requirements (ISO 7176-16) and the ISO 7176-19 Crash Test.

## Own notes

## International addresses

### Australia / New Zealand

Pride Mobility Products  
21 Healey Road  
Dandenong 3175 Victoria  
Australia  
Tel: +61 3 9706-4611  
Fax: +61 3 9706-4622  
Email: prideaustralia@pride-mobility.com.au  
Internet: www.pridemobility.com/international/Australia/australia.asp

### Austria

Sanitätshaus Gebhardt  
Nikolaistrasse 10  
D-83022 Rosenheim  
Tel: (+49) 08031 15466  
Fax: (+49) 08031 34762  
Internet: www.sanitaetshaus-gebhardt.de/

### Belgien

Mobile Belgium  
Blankenbergsesteenweg 14  
B-8000 Brugge  
Tel: +32 (0)50 317919  
Fax: +32 (0)50 311026  
Email: info@mobilescooter.be  
Internet: www.mobilescooter.be

### Denmark

#### Head Office/Jutland

Medema Danmark A/S  
Enggårdvej 7  
Snejbjerg  
DK-7400 Herning  
Tel: +45 7010 1755  
Fax: +45 9718 8835  
Email: info@medema.com  
Website: www.medema.dk

### Denmark

#### Zealand

Medema Danmark A/S  
Ådalen 9  
DK-4600 Køge  
Tel: +45 7010 1755  
Fax: +45 5664 3388  
Email: info@medema.com

### Denmark

#### Funen

Medema Danmark A/S  
Sivlandvænget 6  
DK-5260 Odense S  
Tel: +45 7010 1755  
Email: info@medema.com

### Finland

Respecta OY  
Tenholantie 12  
00280 Helsinki  
Myyntipalvelu Tel: +358 (0)207649748  
Email: myynti@respecta.fi  
Fax: +358 (0)207649735  
Huolto - ja varaosapalvelu Tel: +358 (0)207649747  
Email: huolto@respecta.fi

### France

ICARE  
4 rue d'amsterdam  
F-91250 TIGERY  
Tel: +33 (0)1 60 78 94 84  
Fax: +33 (0)1 69 13 09 78  
Email: icarejmb@wanadoo.fr  
Internet: http://www.icare-jmb.com

### Germany

#### Baden Württemberg

Draisin GmbH  
Von-Drais-Straße 35  
77855 Achern  
Tel (+49) 0 78 41 66 77 0  
Fax (+49) 0 78 41 66 77 88  
Email: info@draisin.com  
Internet: www.draisin.com/

### Germany

#### Baden Württemberg

Elofahrl Palm  
Finkenweg 27  
D-76571 Gaggenau  
Tel: +49 07225 918 831  
Fax: +49 07225 988 070  
Mobile: +49 0171 314 7726  
Email: uwepalm@web.de

### Germany

#### Berlin, Mecklenburg-West Pomerania, Saxony-Anhalt, Thuringia, Brandenburg and Saxony

Conze Elektro-Mobile  
Britzer Damm 12  
D-12347 Berlin  
Tel: +49 030 6789 7969  
Fax: +49 030 6789 7968  
Email: info@elektro-mobile.de  
Internet: www.elektro-mobile.de

## Germany

### Bavaria

Sanitätshaus Gebhardt  
Nikolaistrasse 10  
D-83022 Rosenheim  
Tel: (+49) 08031 15466  
Fax: (+49) 08031 34762  
Email: info@ot-gebhardt.de  
Internet: www.sanitaetshaus-gebhardt.de/

## Germany

### Hesse, Rhineland-Palatinate, Saarland and Lower Franconia

Beromobil GmbH  
Elektromobile Treppenlifte  
Draiser Weg 16  
D-65346 Eltville-Erbach  
Tel: +49 06123 - 60 57 22  
Fax: +49 06123 - 60 57 23  
Email: info@beromobil.de  
Internet: www.beromobil.de

## Germany

### Schleswig-Holstein, Lower Saxony and North Rhine-Westphalia

Wiggers GmbH - Reha / Rollstuhl Werkstatt  
Gerhard Stalling Strasse 47 B  
D-26135 Oldenburg  
Tel: (+49) 0441 36 111 302  
Fax: (+49) 0441 36 111 309  
Email: wiggers.gmbh@ewetel.net  
Internet: www.minicrosser.info; www.ot-wiggers.de

## Holland

Richard van Seenus Nederland B.V.  
Postbus 1425, 1300 BK Almere  
Bolderweg 6, 1332 AT Almere  
Tel: +31 (0) 36 53 20 450  
Fax: +31 (0) 36 53 21 308  
Email: info@vanseenus.nl  
Internet: www.vanseenus.nl

## Norway

Medema gruppen AS  
Postbox 133  
N-1483 Skytta  
Tel: +47 6706 4900  
Fax: +47 6706 4990  
Email: firmapost@medema.no  
Internet: www.medema.no

## Spain

Assessorament I Mobilitat. S.L.  
Marqués de Monistrol, Local 3 (esq. C./ Girona, 29-31)  
08980 Sant Feliu de Llobregat - Barcelona.  
Tel: +34 93 666 55 23  
Fax: +34 93 666 88 85  
Email: info@assessoramentimobilitat.com  
Internet: http://www.assessoramentimobilitat.com

## Sweden

Minicrosser AB  
Bultgatan 28  
S-442 40 Kungälv  
Tel: (+46) 303 245 200  
Fax: (+46) 303 245 228  
Email: info@minicrosser.se  
Internet: www.minicrosser.se

## Switzerland

Degonda Rehab SA  
Industriestrasse 12  
CH-3661 Uetendorf  
Tel: +41 033 345 83 00  
Fax: +41 033 345 83 01  
Email: info@turbo-twist.ch  
Internet: www.turbo-twist.ch

## UK

Mini Crosser Ltd  
The Coach House  
Westonbirt  
Tetbury  
Glos  
GL8 8QS  
Sales, tel: +(44) 0800 043 0029  
Service & Warranty, tel: +(44) 0800 169 9588  
Email: sales@mini-crosser.co.uk  
Internet: www.mini-crosser.co.uk

## USA / Canada

Pride Mobility Products Corp.  
182 Susquehanna Ave.  
Exeter, Pa. 18643  
USA  
Tel: +1 800 800 8586  
Fax: +1 800 800 1636  
Internet: www.pridemobility.com



**medemagroup**